



MADE TO ORDER TRANSFORMATION





## At Solana,

we take our cues by imitating life's patterns, transforming the wonder of the natural world into a stylish and serene setting for both business and pleasure alike. Whether you're looking to establish a peaceful and private setting, require functional protection from the elements, or are simply after that perfect, custom accent piece, the team at Solana are here to finish off your project in style!





## At Solana,

we design, digitally model and cut static moments from a world of infinite patterns. We work with the finest materials including aluminum, aluminlite, corten steel, stainless steel and many composites such as Corian. Our premium coating comes with a Solana 5 year Warranty in all exterior + interior installations. The team at Solana are your "panelization experts" for your projects.

Since 2008 our CNC cutting capability and powder coating process has grown. From Laser Cut Panels to 3D Walls to Tensioned Fabric complete with our own fastening system. Never creating barrier's but capturing the essence of space while providing privacy and protection.

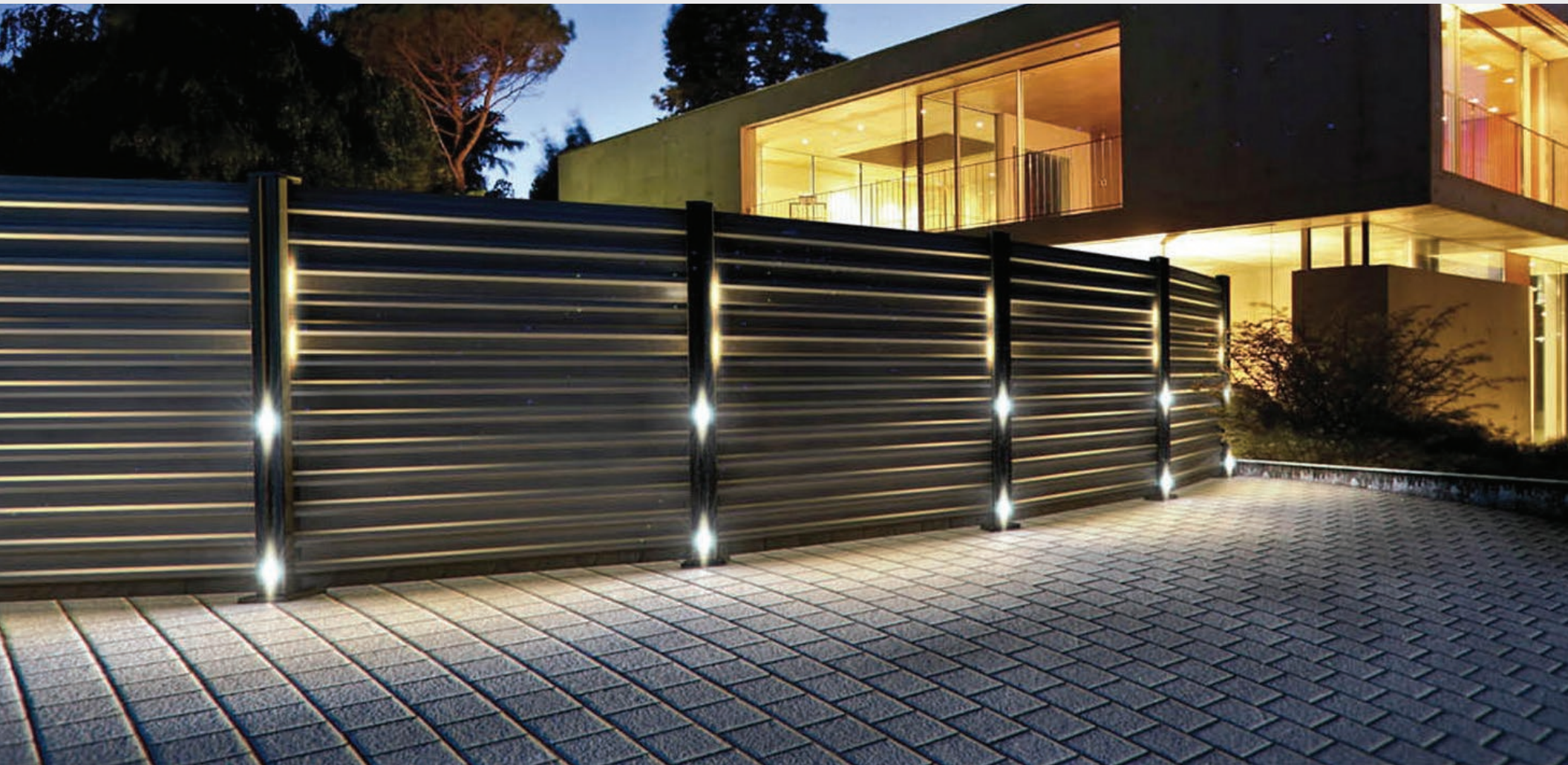

Horizontal Moduboard can be integrated with various materials including Solana Panels, acrylic/glass with custom art or corporate advertising.

STANDARD SIZES: 4'W x 6'H | 4'W x 8'H | 6'W x 6'H | 6'W x 8'H

Custom sizes available.

MAXIMUM SPAN 10'W x 6'H

STANDARD ALUMINUM FINISHES



BLACK MATTE



BENGAL SILVER



CLAY WHITE





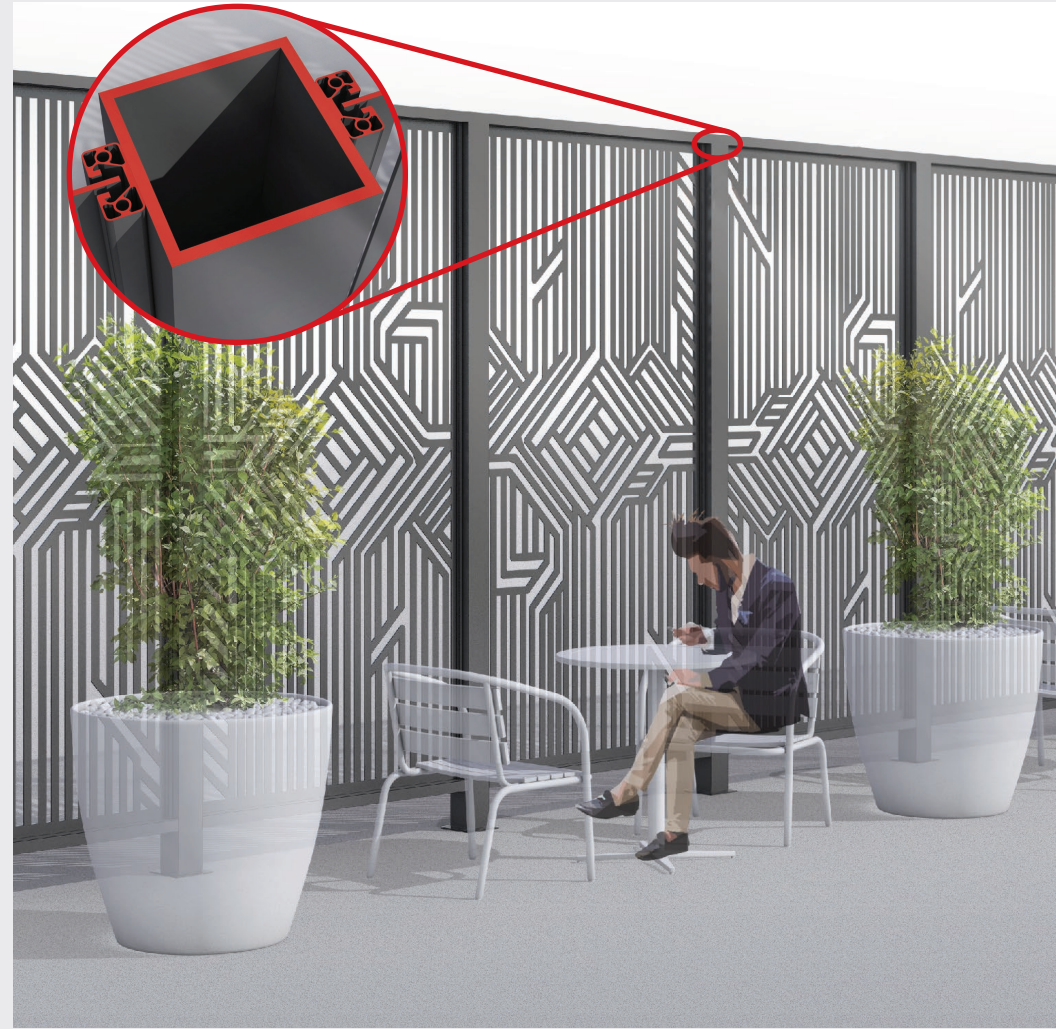
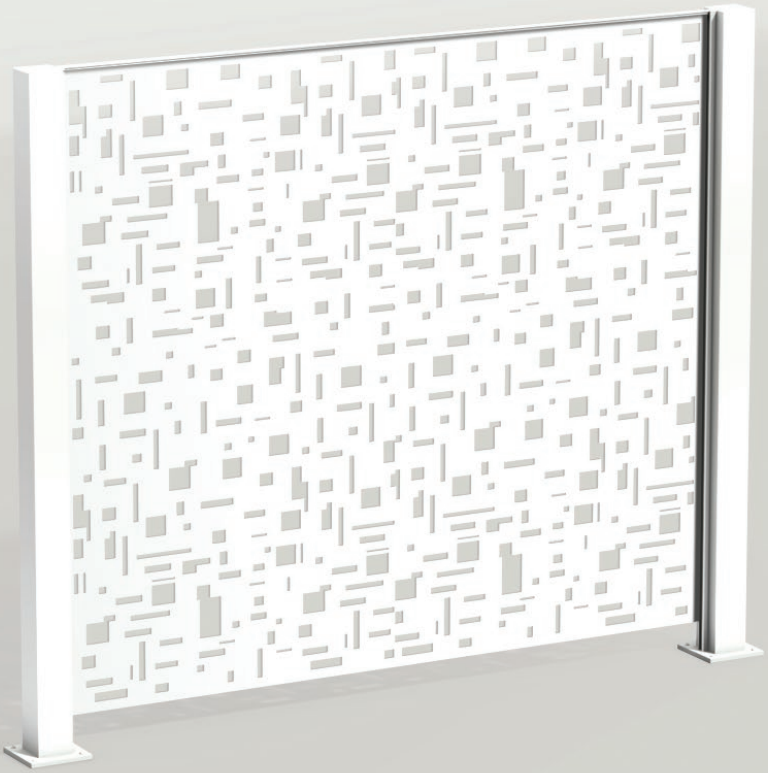

STANDARD SIZES: 4'W x 6'H | 4'W x 8'H | 6'W x 6'H | 6'W x 8'H

Custom sizes available.

MAXIMUM SPAN 10'W x 6'H

STANDARD ALUMINUM FINISHES



BLACK MATTE



BENGAL SILVER



CLAY WHITE





Vertical retractable motorized shade with wireless remote, wind sensor, home automation capabilities.

STANDARD SIZES: 8'W x 8'H | 8'W x 10'H | 10'W x 8'H | 10'W x 10'H

Custom sizes available.

## MESH FABRICS



BUTTERCUP



ORANGE



CARAMEL



MUSCAT



RED



COCOA



BRONZE



WHITE



CHAMPAGNE



BOULDER



CONCRETE



CLOUD



SANDY  
BEIGE



MIDNIGHT  
BLUE



DARK  
TEAL



MOSS  
GREEN



BAMBOO



PEPPER



ALU



BLACK

## STANDARD ALUMINUM FINISHES



BLACK MATTE



BENGAL SILVER



CLAY WHITE





Heavy duty tensioned mesh fabric sails.

STANDARD SIZES: 8'W x 8'H | 10'W x 10'H | 10'W x 16'H | 12'W x 12'H

Custom sizes available.

MAXIMUM SPAN 24'W x 12'L

MESH FABRIC

Performance shade sail material made of highly stable mesh.

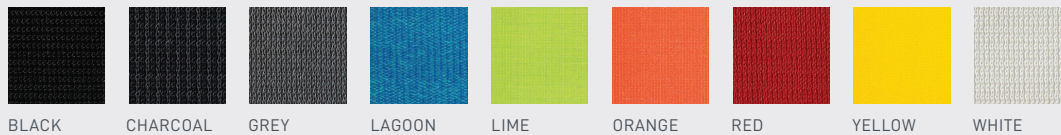

STANDARD ALUMINUM FINISHES





STANDARD SIZES: 8'W x 8'H | 10'W x 10'H | 10'W x 16'H | 12'W x 12'H

Custom sizes available.

STANDARD ALUMINUM FINISHES



BLACK MATTE



BENGAL SILVER



CLAY WHITE



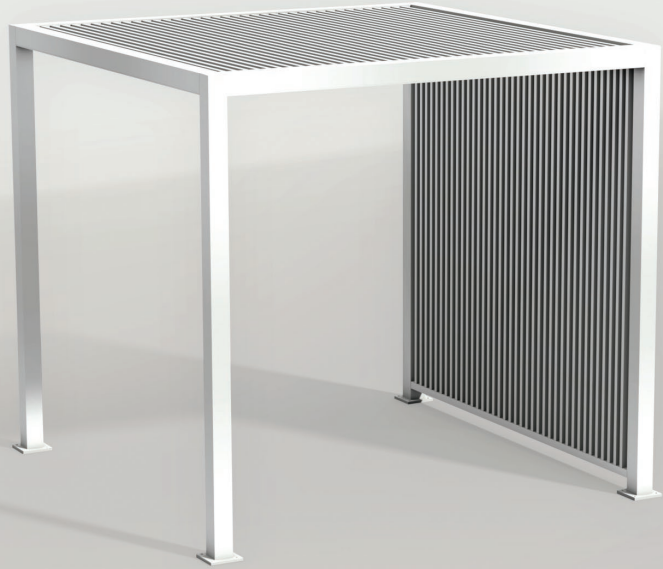

Horizontal or vertical application

STANDARD SIZES: 8'W x 8'H | 8'W x 10'H | 10'W x 8'H | 10'W x 10'H

Custom sizes available.

STANDARD ALUMINUM FINISHES



BLACK MATTE



BENGAL SILVER



CLAY WHITE

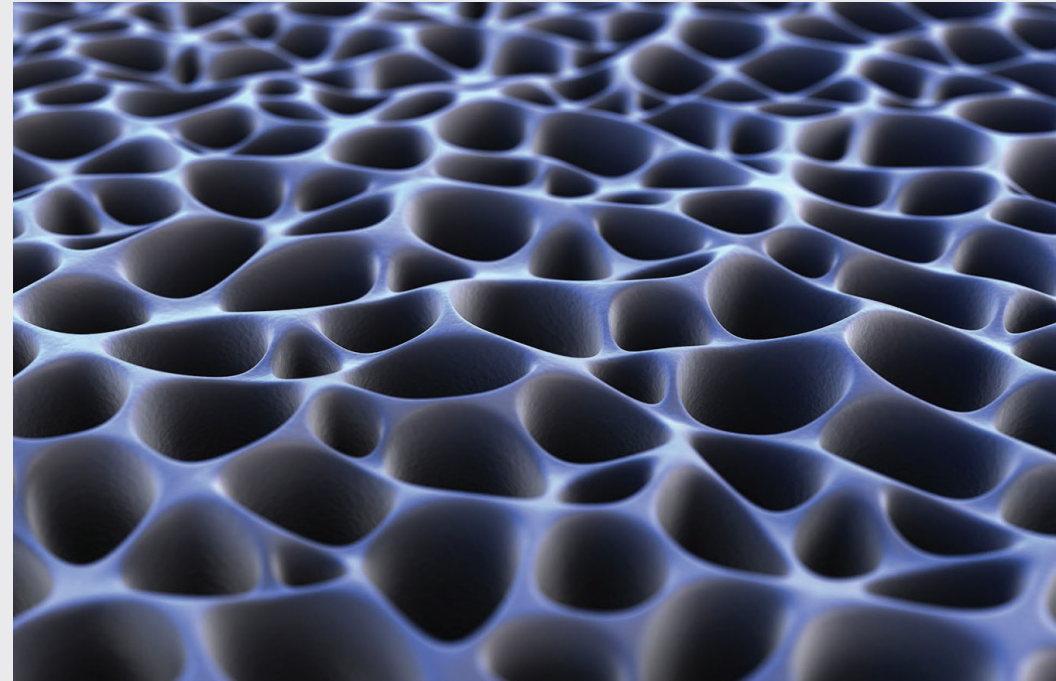

STANDARD SIZES: 8'W x 8'H | 8'W x 10'H | 10'W x 8'H | 10'W x 10'H

Custom sizes available.

STANDARD ALUMINUM FINISHES



BLACK MATTE



BENGAL SILVER



CLAY WHITE





### ACRYLIC FABRIC



Retractable motorized awning with wireless remote, wind sensor, home automation capabilities.

STANDARD SIZES: 8'W x 8'H | 10'W x 10'H | 10'W x 16'H | 12'W x 12'H

Custom sizes available.

MAXIMUM SPAN 23'W x 19'8"L

### FABRICS

- Colors remain bright and luminous for many years
- High UV fastness protecting the colors from fading as well as fabric degradation.
- Outstanding water, dirt and fungus repellency
- Best weather-proof outdoor fiber

SPECIAL FABRIC SOLUTIONS: Fire retardant, digital print

### STANDARD ALUMINUM FINISHES





STANDARD SIZES: 8'W x 8'H | 10'W x 10'H | 10'W x 16'H | 12'W x 12'H

Custom sizes available.

## STANDARD ALUMINUM FINISHES



BLACK MATTE



BENGAL SILVER



CLAY WHITE





STANDARD SIZES: 4'W x 6'H | 4'W x 8'H | 6'W x 6'H | 6'W x 8'H  
Custom sizes available.

#### STANDARD ALUMINUM FINISHES



BLACK MATTE



BENGAL SILVER



CLAY WHITE



STANDARD SIZES: 4'W x 6'H | 4'W x 8'H | 6'W x 6'H | 6'W x 8'H

Custom sizes available.

#### STANDARD ALUMINUM FINISHES



BLACK MATTE



BENGAL SILVER



CLAY WHITE





STANDARD SIZES: 3'W x 6'H | 3'W x 8'H | 4'W x 6'H | 4'W x 8'H  
Custom sizes available.

#### STANDARD ALUMINUM FINISHES



BLACK MATTE



BENGAL SILVER



CLAY WHITE



STANDARD SIZES: 4'W x 6'H | 4'W x 8'H

Custom sizes available.

STANDARD ALUMINUM FINISHES



BLACK MATTE



BENGAL SILVER



CLAY WHITE





STANDARD SIZES: 4'W x 6'H | 4'W x 8'H

Custom sizes available.

STANDARD ALUMINUM FINISHES



BLACK MATTE



BENGAL SILVER



CLAY WHITE

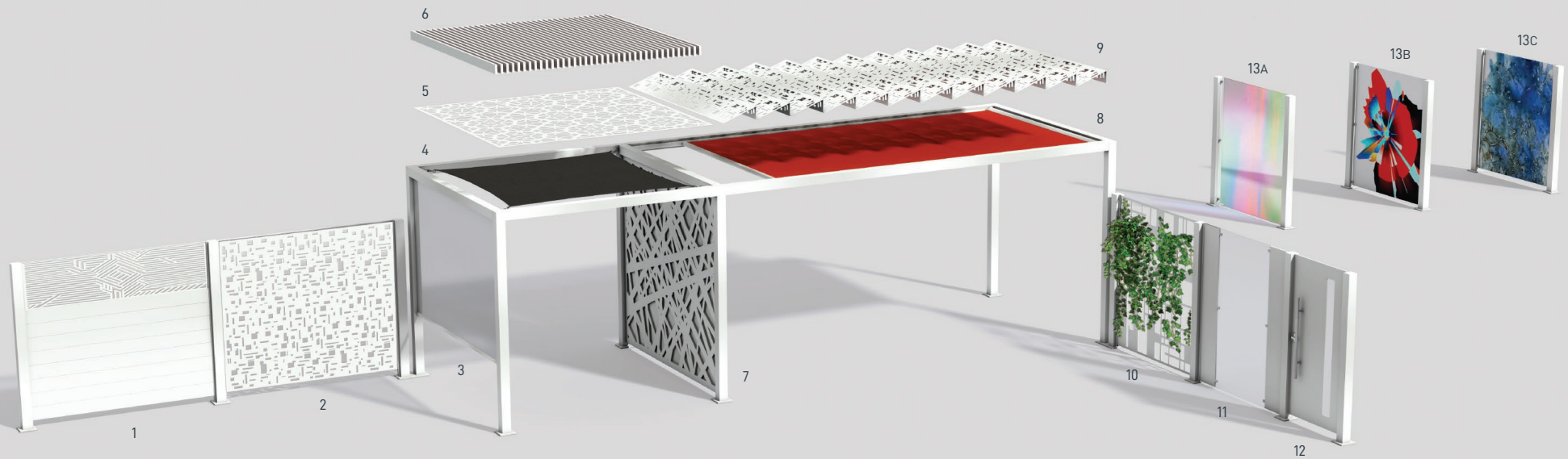

- 1 Vertical Moduboard + Solana Panel
- 2 Solana Panel
- 3 Solana Awning "Eclipse"
- 4 Tensioned Sail
- 5 Solana Panel

- 6 Aluminum Purlins
- 7 Solana 3D Wall
- 8 Solana Awning "Monaco"
- 9 Solana Fixed Louvre
- 10 Living Wall

- 11 Panel with Glass
- 12 ModuGate
- 13A Dichroic Panel
- 13B/C Solana 3M Film Art





MODUDESIGN -SQUARE-8X8 | POSTS-8X4



MODUDESIGN SQUARE-12X12 | POSTS-8X6



MODUDESIGN SQUARE-10X10 | POSTS-8X4



MODUDESIGN RECTANGULAR-10X16 | POSTS-8X6



MODUDESIGN L-SHAPE-10X10+10X16 | POSTS-8X6

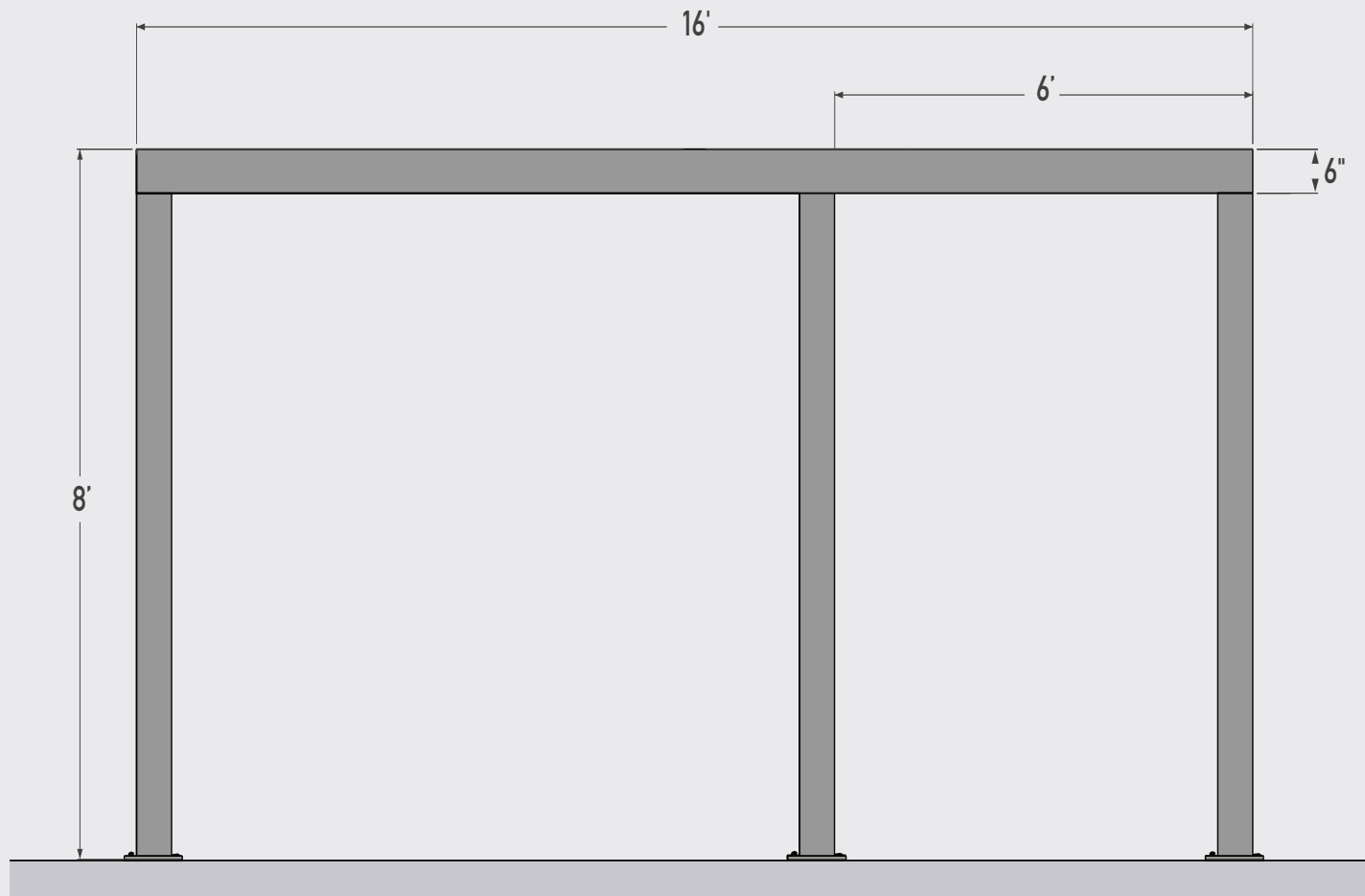



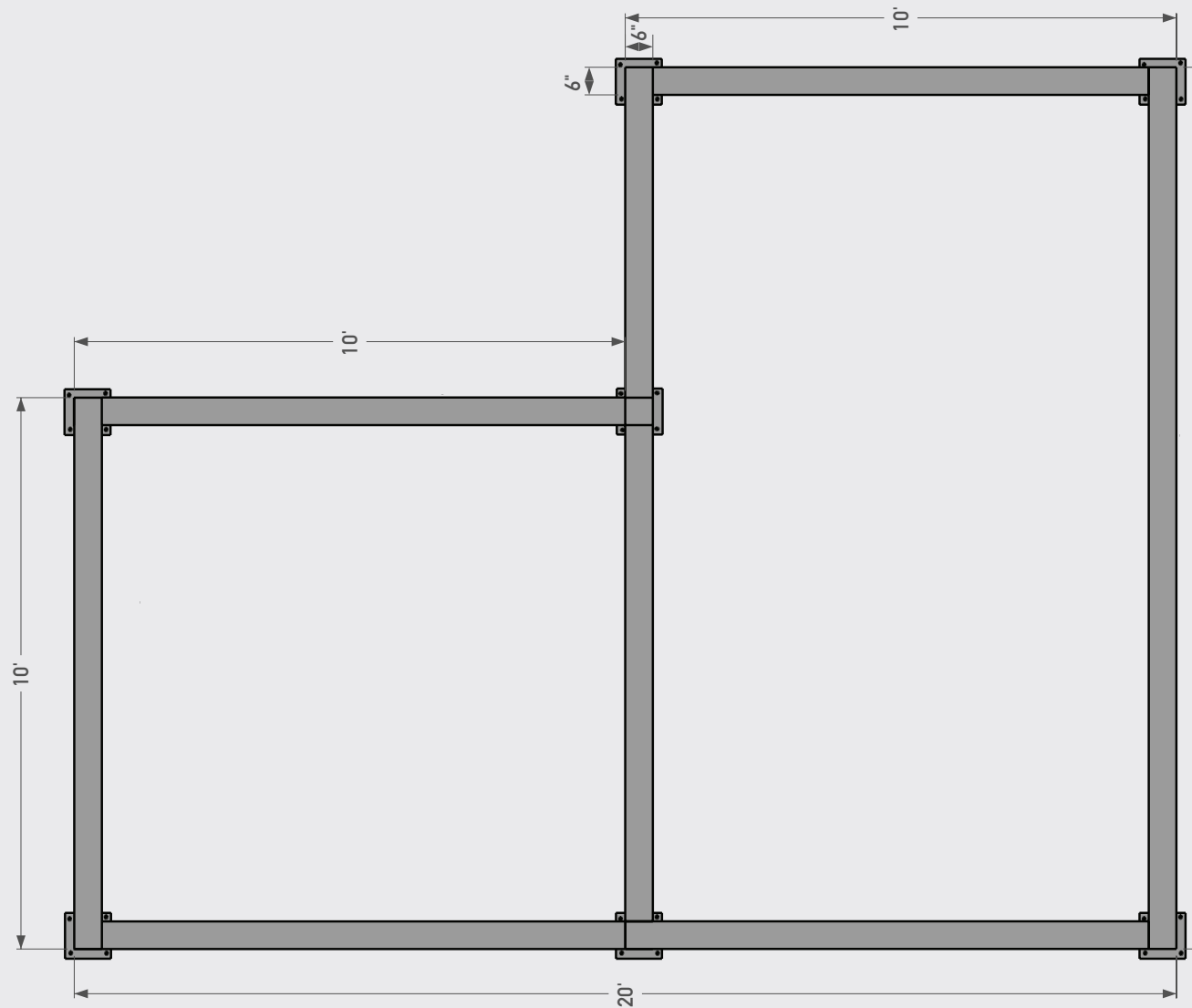



ALUMINUM 6061 EUROPEAN GRADE  
COMMERCIAL GRADE STRUCTURE  
ANY CONFIGURATION  
1/4" WALL THICKNESS  
STRUCTURAL  
COMPLETELY MODULAR  
EASY INSTALLATION  
10 YR WARRANTY  
MORE PROFILES AVAILABLE  
MARINE GRADE PRIMER  
CUSTOM SIZES AVAILABLE  
VERTICAL + HORIZONTAL OPTIONS  
MARINE GRADE PRIMER  
NEW 4"X8" POSTS STRUCTURE COMING SOON

INFINITE POSSIBILITIES



## Contact Us

Solana Panel

33 Worthington Dr., Brantford, ON, N3T 5M1

[info@solanapanel.com](mailto:info@solanapanel.com)

1.416.312.1600

[solanapanel.com](http://solanapanel.com)